

TAUIRA ĀHUAHANGA

Whārangi Tārua 3

Whiriwhiria te horahanga o ngā tapawhā whakarara nei:

1 	2 
3 	4 
5 	6 
7	8

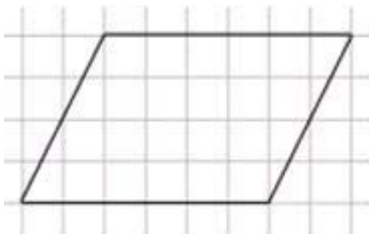
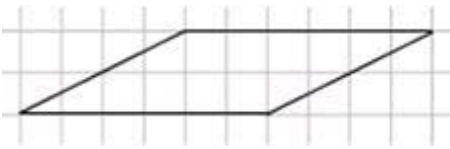
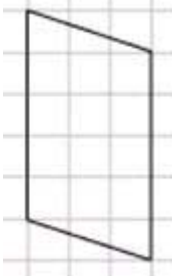
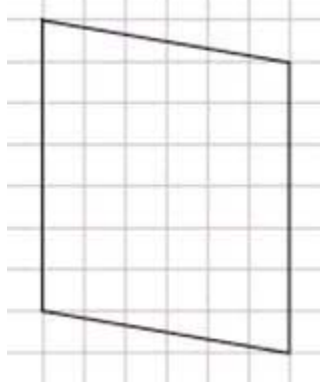
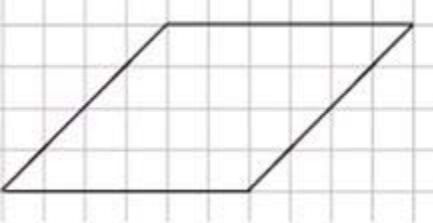
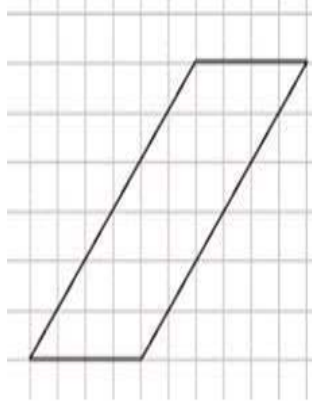
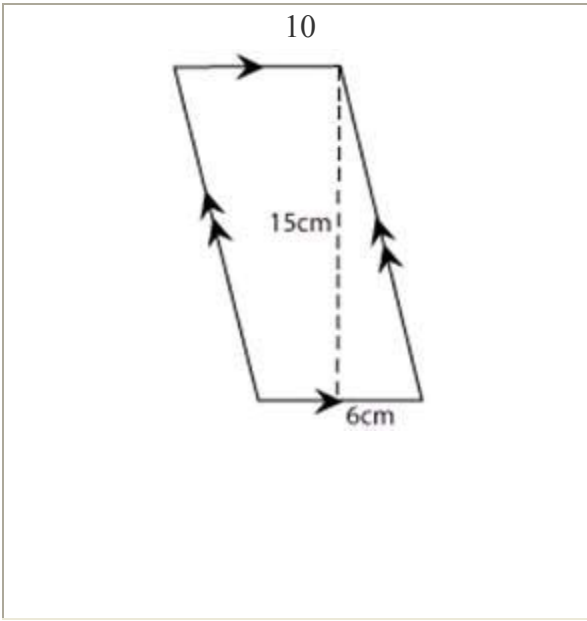
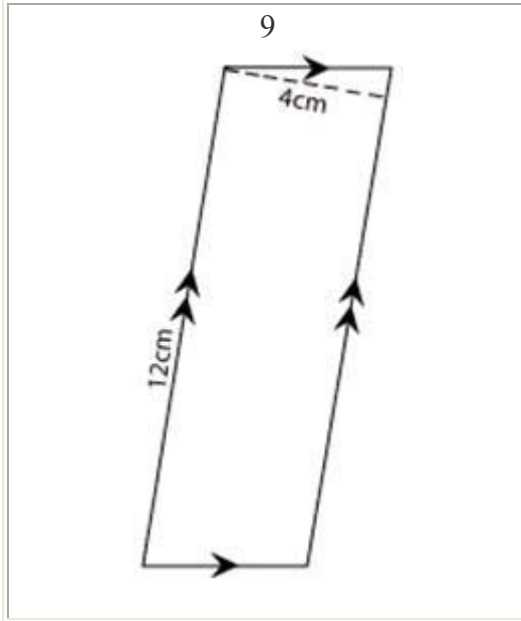
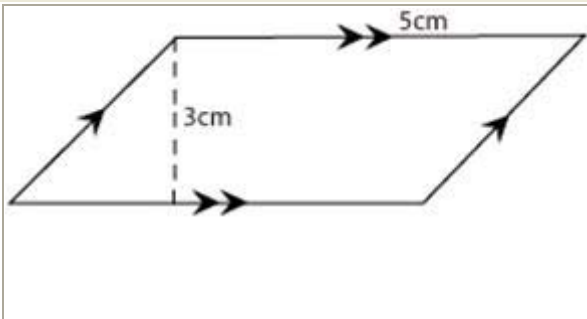
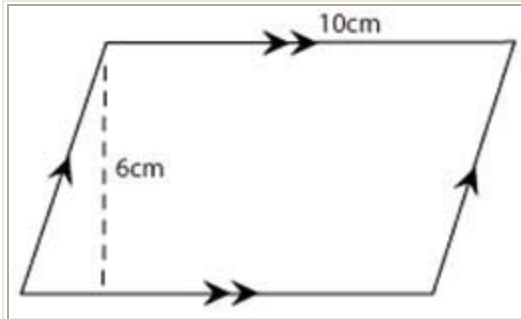

Ko tēhea o ēnei tapawhā he nui rawa atu te horahanga. Whakamāramatia he aha ai.

